

SPB Series

NEW

DIN rail mounting switching mode power supply

■ Features

- DIN rail type and fixing screw type mountings
- Built-in overcurrent protection, output short circuit protection, overheat and over voltage limit protection circuit (SPB-120)
- Built-in power factor correction circuit(SPB-120/240)
- Low-voltage LED indicator
- Slim-type size (SPB-060: W36×H100×L110mm)
- Minimizes noise and ripple
- Improves user safety with terminal cover
- Designed to minimize heat
- Output power : 60W, 120W, 240W
- Output voltage: 12VDC, 24VDC, 48VDC



SPB-060 Series

SPB-120 Series

SPB-240 Series

⚠ Please read "Caution for your safety" in operation manual before using.

■ Ordering information

SPB	—	060	—	24	
				Output voltage	12 12VDC 24 24VDC 48 48VDC
			Output power		060 60W 120 120W 240 240W
			Item		SPB Switching Mode Power Supply

■ Over-heating protection

If the inner temperature of the switching element is around 140°C by overheat, it stops switching operation and becomes open state. Output voltage is not output.

■ Specifications

Model	SPB-060-12	SPB-060-24	SPB-120-24	SPB-240-12	SPB-240-24	SPB-240-48	
Output power	60W		120W	240W			
Input	Voltage 100-240VAC(85-264VAC)						
	Frequency 50/60Hz						
	Efficiency ^{*1} Min. 75%		Min. 80%	Min. 86%	Min. 88%		
	Power factor ^{*1} —		Min. 0.9				
	Current consumption ^{*1} Max. 1.6A		Max. 1.9A	Max. 3.8A			
Power factor correction circuit	—		Built-in				
Output	Voltage	12VDC	24VDC	12VDC	24VDC	48VDC	
	Current	5A	2.5A	5A	10A	5A	
	Voltage adjustment range ^{*2}	Max. ±5%					
	Input variation ^{*3}	Max. ±0.5%					
	Load variation ^{*1}	Max. ±1%			Max. ±1.5%		
	Ripple ^{*1}	Max. ±1%			Max. ±3%	Max. 1.5%	Max. ±1%
	Start-up time ^{*1}	Max. 600ms		Max. 1000ms			
Protection	Hold time ^{*1}	Min. 10ms			Min. 20ms		
	Inrush current protection	Max. 25A(100VAC), Max. 40A(240VAC)			Max. 50A(100VAC), Max. 50A(240VAC)		
	Output over current protection ^{*4}	Min. 105%					
	Output over voltage protection	—		30.0V ±10%	16.0V ±10%	30.0V ±10%	58.0V ±10%
	Output short-circuit protection	Max. 10ms					
Output low-voltage indicate	9.6V±10%	20.0V±10%		10.0V±10%	20.0V±10%	43.0V±10%	
Output indicator	Green LED						

※1: It is for the rated input voltage 100-240VAC, and 100% load.

※2: Adjusting voltage by the output adjuster (V.ADJ), it is changed the below voltage adjustment range(±5%).

※3: It is for the rated input voltage 100-240VAC(85-264VAC), and 100% load.

※4: It is for the rated input voltage 100-240VAC.

DIN rail Mounting Type Switching Mode Power Supply

Specifications

Model	SPB-060-12	SPB-060-24	SPB-120-24	SPB-240-12	SPB-240-24	SPB-240-48
Insulation resistance	Min. 100MΩ(at 500VDC megger between all input terminals and output terminals)					
Dielectric strength	3000VAC 50/60Hz for 1 min. (between all input terminals and output terminals)					
	1500VAC 50/60Hz for 1 min. (between all input terminals and F.G.)					
Vibration	0.75mm amplitude at frequency of 10 to 55Hz (for 1 min.) in each of X, Y, Z directions for 2 hour					
Shock	300m/s ² (approx. 30G) in each of X, Y, Z directions for 3 times					
EMS	Conforms to EN61000-6-2					
EMI	Conforms to EN61000-6-4					
Safety	IEC60950, IEC50178					
Environment	Ambient temperature	-10 to 50°C, storage: -25 to 65°C				
	Ambient humidity	25 to 85%RH, storage: 25 to 90%RH				
Protection	IP20(IEC standard)					
Unit weight ^{※5}	Approx. 347g(approx. 274g)		Approx. 570g (approx. 466g)	Approx. 866g(approx. 736g)		

※5: The weight is with packaging and the weight in parentheses is only unit weight.

※Environment is rated at no freezing or condensation.

Output deterring curve by ambient temperature

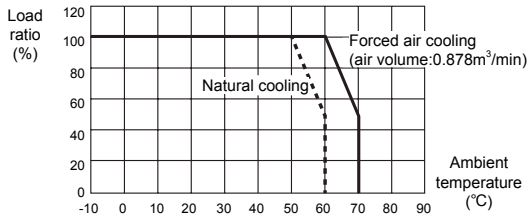

Recommended power input voltage wire for model

Recommended power input voltage wire	AWG21-19	AWG18-16
Model	SPB-060-12 SPB-060-24 SPB-120-24	SPB-240-12 SPB-240-24 SPB-240-48

Dimensions

● SPB-060 Series

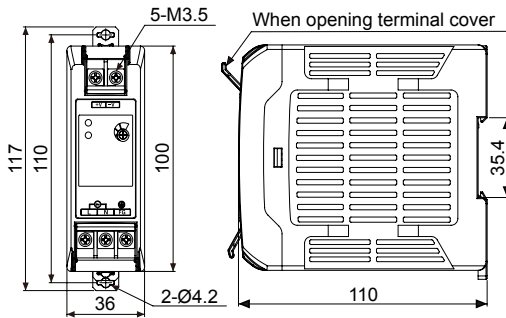

※Side sizes are same as SPB-060/120 /240 Series.

● SPB-120 Series

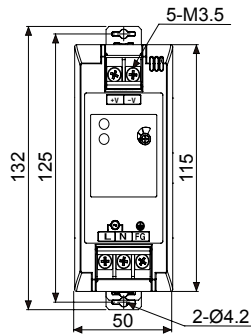

● SPB-240 Series

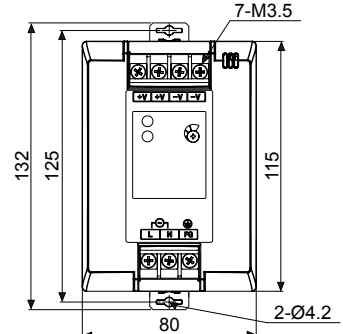

(unit: mm)

Part descriptions

● SPB-060/120 Series

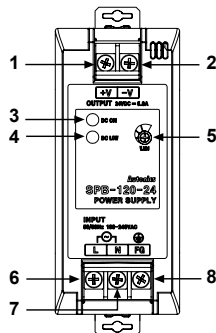

1. Output power [+V] terminal
2. Output power [-V] terminal
3. Output(DC ON) indicator(green)
4. Output low voltage (DC LOW) indicator(red)
5. Output voltage adjuster(V.ADJ)
6. Input power [L] terminal
7. Input power [N] terminal
8. Frame ground [F.G.] terminal

● SPB-240 Series

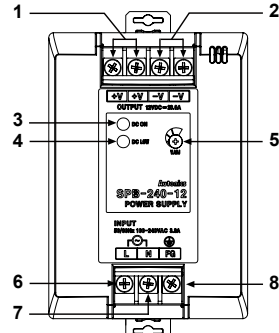

(A)	Photo electric sensor
(B)	Fiber optic sensor
(C)	Door/Area sensor
(D)	Proximity sensor
(E)	Pressure sensor
(F)	Rotary encoder
(G)	Connector/Socket
(H)	Temp. controller
(I)	SSR/ Power controller
(J)	Counter
(K)	Timer
(L)	Panel meter
(M)	Tacho/ Speed/ Pulse meter
(N)	Display unit
(O)	Sensor controller
(P)	Switching mode power supply
(Q)	Stepper motor& Driver&Controller
(R)	Graphic/ Logic panel
(S)	Field network device
(T)	Software
(U)	Other

SPB Series

■ Installation

○ DIN rail mounting

● To mount the power supply on the rail,

First put the power supply on the part ㉑ of the rail and then press it for the direction ㉒.

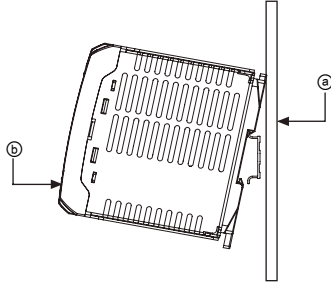

● To remove the power supply on the rail

First put a screw driver into the part ㉓ and push it downward.

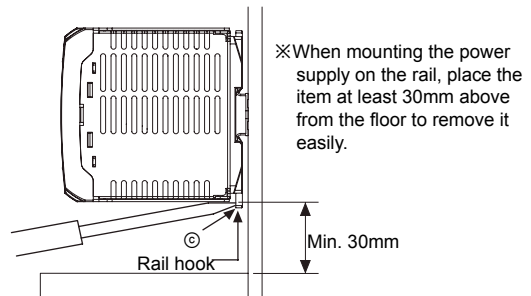

○ Panel mounting

● When there is no rail

This power supply has two hooks. If pushing these at the arrows direction as below figure, you can mount this power supply with general bolts.

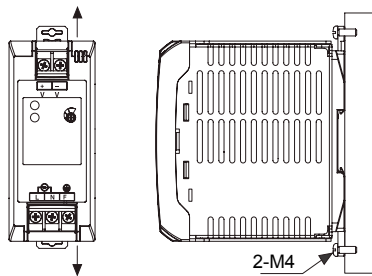

■ Caution for using

- Caution for operating
- This product does not have the function for parallel or series operation.
- The output current must be used within the rated specification.
If over current is applied to the product, over current protection is operating.
It causes shorten the life cycle of the product.
- The output voltage must be used within the rated output specification.
- For the product, which has the control function for over-voltage, if making the output voltage adjuster(V.ADJ) to over rated voltage, the function starts to work.
- This product has the function of over-heating protection.
The over-heating protection operates when the product has over-heating condition.
The product normally operates if the load is removed for over 5 minutes.
- In case of the SPB-060, it does not have the harmonics suppression and power factor improvement circuit.
To improve harmonics suppression and power factor, install the additional device.
- In case of the SPB-060, it uses condenser rectification, and power factor is within 0.4 to 0.6 range. To use a cabinet panel or a electric transformer, select input power capacity of this product as below formula.

$$\text{Input apparent power[VA]} = \frac{\text{Output active power[W]}}{\text{Power factor} \times \text{Efficiency}}$$

- This product is provided with a noise filter, but noise is variable according to operating conditions such as installation environment and wiring.
- When the inner fuse is damaged, replace the fuse of same specification.

DIN rail Mounting Type Switching Mode Power Supply

■ Caution for using

- Caution for mounting
- Mount this product on the surface of metal panel vertically for the reliability.
- Please mount this product at a well-ventilated place in order to increase the heat radiation efficiency.
- Effective mounting

- Natural cooling mounting

When installing more than two power supplies, min. 20mm distance is required to radiate heat effectively. Assure min. 75mm distance of the upper or the lower product and mount the products as following figure.

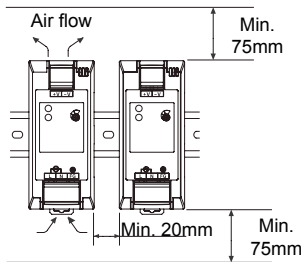

- Forced air cooling mounting

For effective heat radiation, assure min. 75mm distance of the upper and lower product to flow air as the below figure. Install a fan which min. air volume is 0.878m³/min within 50mm from the product to maintain the reliability of the product.

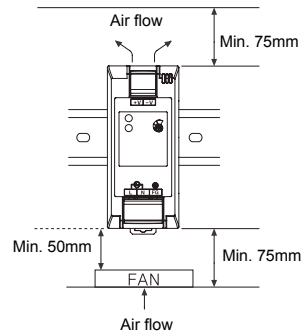

- Dielectric or insulation resistance test when this unit is installed in the control panel.
- Separate the unit completely from a control panel circuit.
- Short all terminals of the unit.
- Caution for connecting the input power terminal
Connect input line (AC) to the input terminal correctly.
When you connect this to the other terminal, it may cause damage to the power supply.
- Do not use this unit at below places.
 - Place where there are severe vibration or impact.
 - Place where strong alkalis or acids are used.
 - Place where there is direct ray of the sun.
 - Place where strong magnetic field or electric noise are generated.
- Installation environment
 - It shall be used indoor
 - Altitude max. 2000m
 - Pollution Degree 2
 - Installation Category II

(A)	Photo electric sensor
(B)	Fiber optic sensor
(C)	Door/Area sensor
(D)	Proximity sensor
(E)	Pressure sensor
(F)	Rotary encoder
(G)	Connector/Socket
(H)	Temp. controller
(I)	SSR/Power controller
(J)	Counter
(K)	Timer
(L)	Panel meter
(M)	Tacho/Speed/Pulse meter
(N)	Display unit
(O)	Sensor controller
(P)	Switching mode power supply
(Q)	Stepper motor& Driver&Controller
(R)	Graphic/Logic panel
(S)	Field network device
(T)	Software
(U)	Other